



LABELING TECHNOLOGY

 di-soric

WELCOME TO DI-SORIC

ABOUT THE INVENTOR OF THE FORK LIGHT BARRIER: DI-SORIC.

For over 35 years, we have been producing and selling sensors used in industrial automation, primarily in assembly and handling technology, the automotive, electronics and pharmaceutical industries and packaging technology. Other cornerstones of our product range are image processing and identification systems, high-quality LED lighting and products for work safety.

Our subsidiary, di-soric Solutions GmbH & Co. KG, specializes in the business areas of image processing and identification.

What sets us apart: In addition to high-quality products, di-soric Solutions prioritizes complete solutions, developed for you, which we call "engineered solutions."

We are involved in all phases, from consultation to project engineering and even implementation.

We combine our resources to help you ensure that your production processes are as precise, free of error and cost-effective as possible, now and in the future.





DI-SORIC FACTS

- **100% OWNER-MANAGED**

- **HEADQUARTERS**

Urbach, Germany

- **TECHNOLOGY AND PRODUCTION CENTER**

Lüdenscheid, Germany

- **REPRESENTATIVES AND BRANCH OFFICES**

in more than 40 countries

- **CERTIFICATIONS**

IQNet, DQS - ISO 9001:2015, UL, RoHS, GS1

OUR PROMISE TO YOU:

SOLUTIONS.
CLEVER.
PRACTICAL.



SOLUTIONS.

**To us, finding solutions means
providing you with exactly the right solution
for the job.**

- Solution-oriented consultation and implementation
- Product portfolio for numerous application areas
- Engineered solutions for industrial image processing



CLEVER.

To us, being clever means **finding new, smart, unconventional and therefore more effective solutions.**

- Added value for product and application
- Efficient in function and application
- Openness and flexibility for the best solutions



PRACTICAL.

To us, being practical means **being available, taking a straightforward approach and communicating as partners.**

- Solution-oriented consultation and technical expertise
- Straightforward, cooperative and dynamic approach
- Address what is important and forget about unnecessary factors.

SERVICE AREAS

DETECTION

Precision is the top priority in automated assembly and handling processes. Our sensors are ideal for checking the alignment and position of small, fast-moving parts that are difficult to detect.

In addition, assembly is fast and simple and the sensors are very to configure and extremely durable.

MEASURING

Measuring sensors can determine distances and dimensions of objects or position system components. Whether optical, ultrasonic or inductive sensors or complete image processing solutions are called for, di-soric has a wide product range for measurement tasks.

The products and solutions are tailored to sophisticated applications and stand out for their customized ranges, degrees of precision and measurement rates.

QUALITY CONTROL

Each process must be carried out precisely and reliably to ensure that the quality of a finished product complies with its specifications.

When combined with engineered solutions, our vision sensors and systems, color sensors and high-quality LED lighting systems ensure maximum efficiency and quality in your processes.

IDENTIFICATION

Reliable object identification is vital to ensuring a fault-free production process.

Our mobile and permanently installed barcode and 2D code readers ensure comprehensive tracking and ensure the high quality of your products during the individual process steps.

IO-LINK

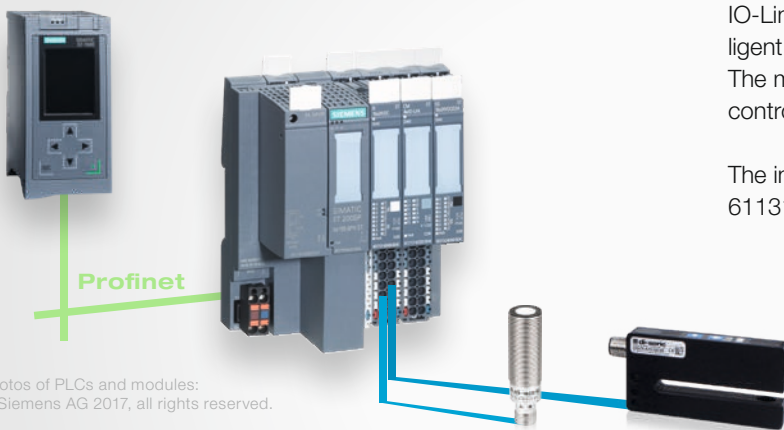

Photos of PLCs and modules:
© Siemens AG 2017, all rights reserved.

IO-Link provides a point-to-point connection between intelligent IO-Link sensors or actuators and an IO-Link master. The master is the interface to the PLC control system and controls communication with the connected sensors.

The international IO-Link standard (in accordance with IEC 61131-9) is now regarded as an **"enabler for Industry 4.0."**



5 REASONS FOR IO-LINK

1. **Cost reduction** thanks to reduced stockkeeping
2. **Implementation of innovative machine concepts** thanks to consistent communication
3. **Shortened commissioning times** with cabling according to standards
4. **Increased machine productivity** through independent parameter configuration and identification
5. **Revolutionizing maintenance** through self-diagnostics

CONTENTS

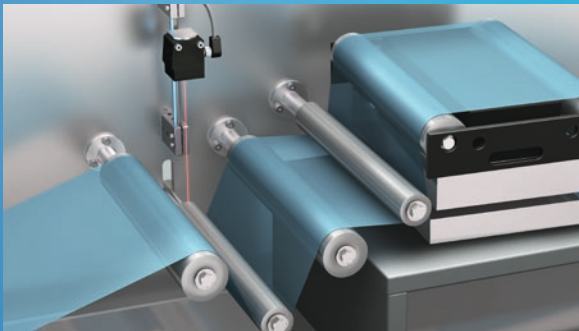

CREATING LABELS

Roller diameter check	8
Loop control system	9
Web edge control	9
Punching and identifying labels	9



DISPENSING LABELS

Identifying and positioning labels	11
Label sensors	12
Detecting empty label coil	14
Detecting end position at guide roller	15
Triggering labeling	15



CHECKING LABELING

Position check for label fit	16
Traceability of products	17
Reading and verifying plain text	17
Checking cover color	17

TEAMWORK BY DI-SORIC

	18
--	----

SERVICE

	19
--	----

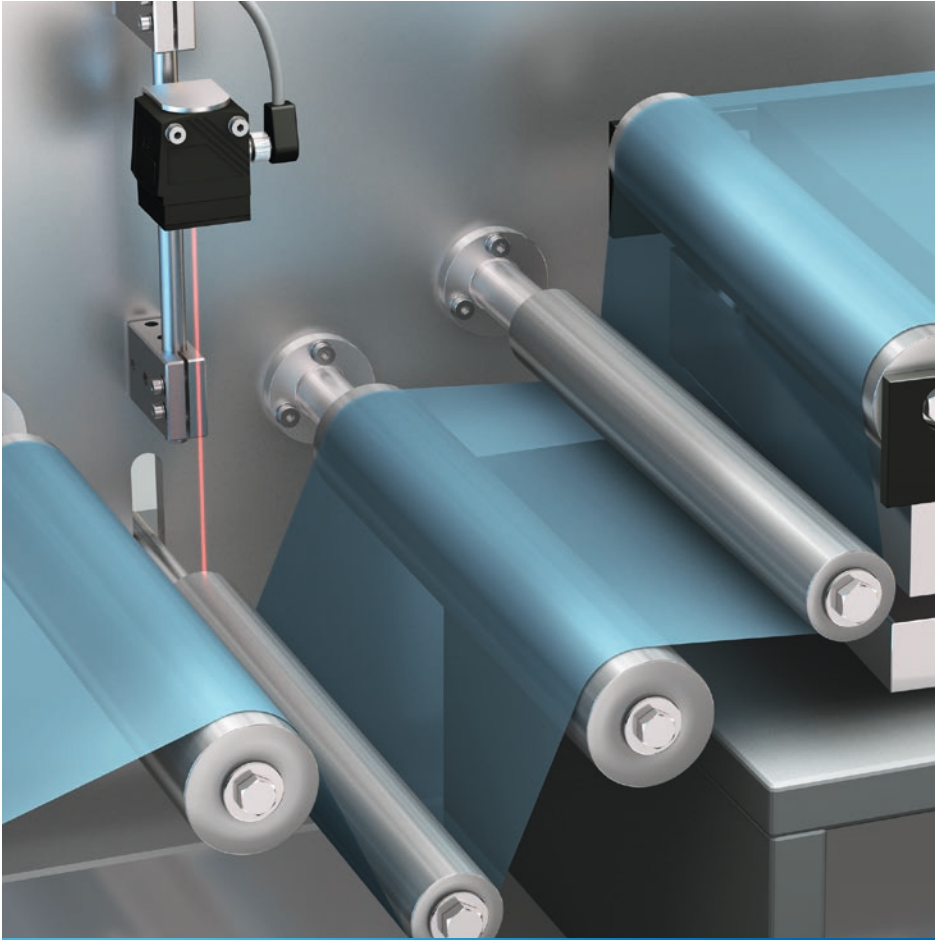

FOR PRECISION AND MAXIMUM PRODUCTIVITY.

The large number of applications and label types requires specific manufacturing methods. In order to optimally equip the various process steps and machine types, di-soric provides a range of sensors for printing, coating and laminating as well as for punching labels.

Through simple adjustment, our sensors make it easy to achieve fast, process-reliable and flexible production of varying products and batch sizes.

Roller diameter check

Ultrasonic sensor

US 18 M 800 IU-B4



- Measuring range 80 – 800 mm
- Measurement regardless of surface
- Insensitive to dirt
- Output of current/voltage measured values analog or digital over IO-Link
- Short, compact metal housing



Loop control system

Optical distance sensor
LHT 9-45 M

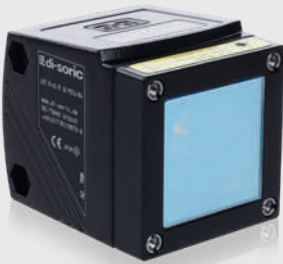

- Red-light laser for easy alignment
- Analog current/voltage output, up to 2 switching outputs
- 4-digit display for indicating measured values and parameter settings
- Measurement virtually unaffected by surface
- Robust metal housing and resistant glass front window

Web edge control

Ultrasonic fork sensor
USGT 30/8 U-B4



- Compact ultrasonic edge sensor
- Visible area ± 4 mm
- Insensitive to contamination with dust
- Sensing acoustically non-transmissive materials such as paper, plastic and metal foil regardless of material transparency
- Large linearized analog range
- Very high repeatability

Punching and identifying labels

Optical label sensor
OGUTI 005/50



- Fast, for maximum belt speeds up to 500 m/min
- Exact label detection
- Ideal for non-transparent labels
- Intuitive auto-teach for easy product change during ongoing operation
- Large fork opening enables identification of thin and thick labels

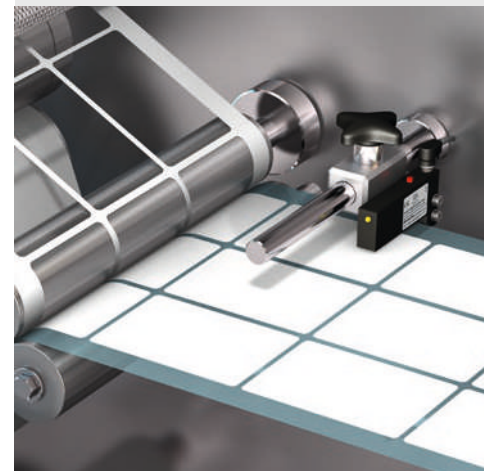
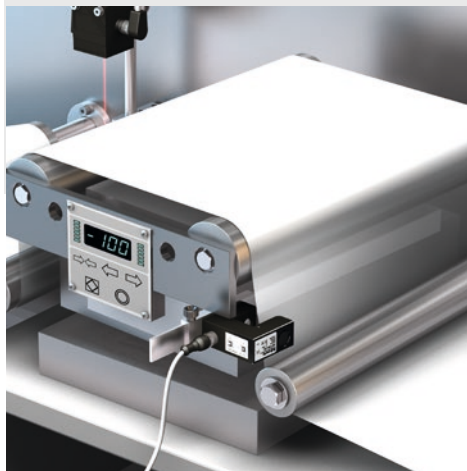
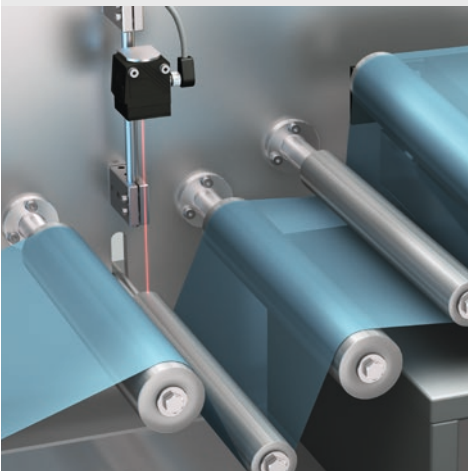



DISPENSING A WIDE VARIETY OF LABELS WITH SPEED, PRECISION AND FLEXIBILITY.

The number of labels processed on the market is steadily increasing. The spectrum ranges from transparent labels for the non-label look to printed and partially metallic labels and even thick booklets with integrated instruction leaflet.

di-soric label sensors are equipped with auto-teach. The ideal switching point can be determined with the press of a button while the label tape is moving through the label sensor. This way, the auto-teach feature allows for extremely fast label changes while the process is running. In addition to button operation, remote teach variants for optical, capacitive and ultrasonic label sensors are also available.

Identifying and positioning labels

Optical label sensor OGUTI 005/50



- Auto-teach with operating button
- Detection of paper and non-transparent labels
- For processing thin to thick booklets with integrated instruction leaflet
- Highest dispenser precision makes optimum labeling possible
- The flat side enables installation at the label dispensing edge
- Also for wide labels with fork depths up to 100 mm (OGUTI 005/1000)

Capacitive label sensor KSSTI 1000/80



- Auto-teach with operating button
- Detection of thin foil labels, transparent labels and paper labels
- High process and long-term stability thanks to optimal compensation of temperature and humidity
- Detachable lower part of the housing allows for installation at the label dispensing edge
- Flat design and various fork openings available











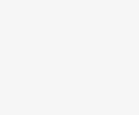

Ultrasonic label sensor UGUTI 6/70



- Auto-teach with operating button
- Detection of metallic foil labels, transparent labels and paper labels
- For processing thin to thick booklets with integrated instruction leaflet
- IO-Link for configuration and format change
- Parallel operation of switching output and IO-Link
- Additional warning output



DISPENSING LABELS

DETECTION	Labeling: Non-transparent Carrier material: Non-transparent	Labeling: Non-transparent Carrier material: Transparent	Labeling: Transparent Carrier material: Transparent	Labeling: Metallic Carrier material: Transparent / non-transparent	Labeling: Booklet Carrier material: Transparent / Non-transparent
OPTICAL OGUTI					
CAPACITIVE KSSTI					
ULTRASONIC UGUTI					

Optical label sensors

detect both thin and thick paper labels with outstanding speed and precision thanks to their large fork openings. They stand out for their extremely high dispensing precision and reproducibility, making maximum belt speeds possible. Using auto-teach, they can be taught in to new materials quickly and intuitively.

Capacitive label sensors

are the solution of choice for detecting thin transparent labels, foil labels and paper labels. They show their strengths particularly well wherever high belt speeds are required. Using auto-teach, they are taught in to new materials quickly and intuitively.

Ultrasonic label sensors

can be used universally for a wide variety of label materials. They detect not only thin and thick transparent, foil and paper labels but also metallic labels reliably. The innovative dual operation concept—implemented using either IO-Link or auto-teach—makes it possible to put the sensors into operation quickly.

OPTICAL LABEL SENSORS OGUTI



OGUTI 002



OGUTI 005/50



OGUTI 005/100

Fork opening	Fork depth	Switching output	Belt speed	Reproducibility	Activation time	Remote teach	
2 mm	40 mm	pnp	≤ 500 (m/min) ¹⁾	$\leq 50 \mu\text{m}^2$	166 μs	<input type="checkbox"/>	OGUTI 002 P3K-TSSL
		pnp					OGUTI 002 FP3K-TSSL
		pnp / npn					OGUTI 002PN3K-TSSL
5 mm	50 mm	Push-pull	≤ 500 (m/min) ¹⁾	$\leq 50 \mu\text{m}^2$	166 μs	<input type="checkbox"/>	OGUTI 005/50 G3K-TSSL
5 mm	100 mm	pnp	≤ 500 (m/min) ¹⁾	$\leq 50 \mu\text{m}^2$	166 μs	<input type="checkbox"/>	OGUTI 005/100 P3K-TSSL
		pnp					OGUTI 005/100 FP3K-TSSL
		pnp / npn					OGUTI 005/100 PN3K-TSSL

CAPACITIVE LABEL SENSORS KSSTI



KSSTI 400/600/1000



KSSTI 600/80 1000/80 IBS



KSSTI 600/80 1000/80 AIBS

Fork opening	Fork depth	Switching output	Belt speed	Reproducibility	Activation time	Remote teach	
0.4 mm	50 mm	Push-pull	300 (m/min) ¹⁾	$\leq 150 \mu\text{m}^2$	$\leq 600 \mu\text{s}$	<input type="checkbox"/>	KSSTI 400 G3K-TSSL
0.6 mm	50 mm	Push-pull	300 (m/min) ¹⁾	$\leq 150 \mu\text{m}^2$	$\leq 600 \mu\text{s}$	<input type="checkbox"/>	KSSTI 400 FG3K-TSSL
							KSSTI 600 G3K-TSSL
1.0 mm	50 mm	Push-pull	300 (m/min) ¹⁾	$\leq 150 \mu\text{m}^2$	$\leq 600 \mu\text{s}$	<input type="checkbox"/>	KSSTI 600 FG3K-TSSL
							KSSTI 1000 G3K-TSSL
0.6 mm	85 mm	Push-pull	300 (m/min) ¹⁾	$\leq 150 \mu\text{m}^2$	$\leq 600 \mu\text{s}$	<input type="checkbox"/>	KSSTI 1000 FG3K-TSSL
1.0 mm							KSSTI 600/80 FG3LK-IBS
0.6 mm	85 mm	Push-pull	300 (m/min) ¹⁾	$\leq 150 \mu\text{m}^2$	$\leq 600 \mu\text{s}$	<input type="checkbox"/>	KSSTI 1000/80 FG3LK-IBS
1.0 mm							KSSTI 600/80 FG3LK-AIBS
0.6 mm	85 mm	Push-pull	300 (m/min) ¹⁾	$\leq 150 \mu\text{m}^2$	$\leq 600 \mu\text{s}$	<input type="checkbox"/>	KSSTI 600/80 FG3LK-AIBS
1.0 mm							KSSTI 1000/80 FG3LK-AIBS

ULTRASONIC LABEL SENSORS UGUTI



UGUTI 6/70 G6-RB5



UGUTI 6/70 G6-B5

Fork opening	Fork depth	Switching output	Belt speed	Reproducibility	Activation time	Plug connection	
6 mm	70 mm	2 independent outputs, push-pull	250 (m/min) ¹⁾	$\leq 200 \mu\text{m}^2$	$\leq 250 \mu\text{s}$	at the back	UGUTI 6/70 G6-B5
						at the top	UGUTI 6/70 G6-RB5

¹⁾ 2 mm label and 2 mm gap²⁾ Depends on the label material and carrier material



SUPPORTING SENSORS FOR DISPENSING LABELS FAST AND WITH PRECISION.

From simple object detection to high-precision position detection, a large number of sensors with a wide array of properties are used when labels are produced and dispensed.

Inductive sensors

are always used when metallic objects are to be detected reliably.

Optical sensors

stand out for their high switching frequency, short activation time and high resolution—simply put, they are fast and efficient.

Detecting empty label coil

Energetic diffuse sensor

OT 31 K 400 P3-3



- Versatile and compact product series with large function reserve
- Easy operation, sensitivity adjustment with potentiometer
- Switch for light/dark switching
- Fully molded electronic circuitry, vibration-resistant
- Short activation time, therefore ideal for dynamic applications

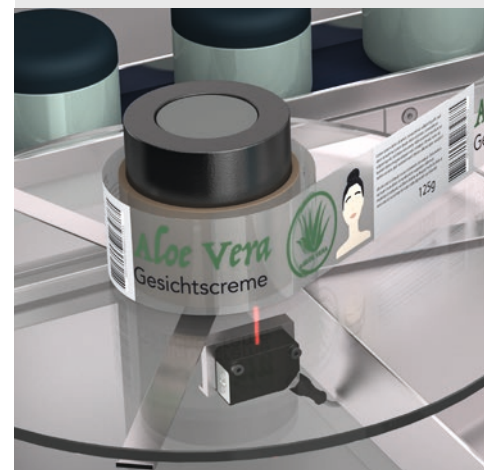

Detecting end position at guide roller

Inductive proximity switch
DCC 05 V 2.5 PSLK



- Compact M5 design
- Large switching distance
- Robust stainless steel housing
- Highly flexible cable
- Clearly visible LED

Triggering labeling

Retroreflective sensor
OR 18-1 FKR 3600 P3



- Universal design with high function reserve
- Universal mounting options
- Low installation depth thanks to angled optics
- Sensitivity adjustment using a potentiometer

Fiber-optic sensors
OLK 71



- Ideal for labeling machines thanks to short activation time and large function reserve
- Two easy-to-read digital LED displays for the target value and actual value
- Fast configuration thanks to intuitive 4-button operation
- Long ranges, short activation time
- KLER fiber optics: low installation depth thanks to 90° deflection

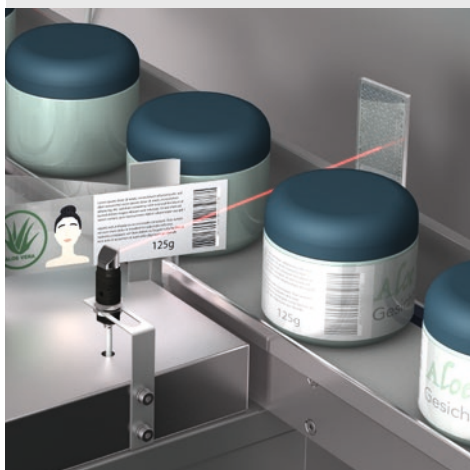



ERROR-FREE, FAST QUALITY CONTROL AND BACKTRACKING OF LABELING.

In order to ensure secure, complete backtracking, many products are marked with corresponding codes and readable texts.

The ID and vision products that we offer ensure that 1D and 2D codes as well as plain text can be read and verified reliably.

Position check for label fit

Vision sensor

CS 50



- Ideal for high-performance labeling machines with up to 2520 checks/minute
- As intuitive and easy to use as a sensor
- The world's smallest vision sensor
- Interchangeable light, filter and polarizer
- 5 powerful tools for completing a wide variety of jobs
- Interfaces integrated:
Profinet / Ethernet / TCP-IP / RS 232



Traceability of products

ID system
ID-10



- Reliable decoding of 1D and 2D codes
- Extremely fast scanning results of up to 60 decoding processes/second
- Dual zone lens: Fast and reliable decoding despite fluctuating working distances
- Manual or automatic trigger
- Easy start-up

Reading and verifying plain text

PC-based
vision system



nVISION

- Variable working distances and image fields provide great flexibility
- Visualization of checks in a web browser
- Compliance with required quality standards thanks to decoding and a text quality check in one process
- Carries out various inspection tasks simultaneously

Checking cover color

Color sensor
FSB 10



- Ideal for fast checking processes thanks to short activation time
- Easy operation with teach-in using button or input
- Easy integration thanks to compact design
- Robust: Metal housing in IP67 protection type, highly flexible fiber-optic cables
- Large operating ranges of up to 60 mm thanks to focus optics



SOLUTIONS. CLEVER. PRACTICAL. TEAMWORK BY DI-SORIC

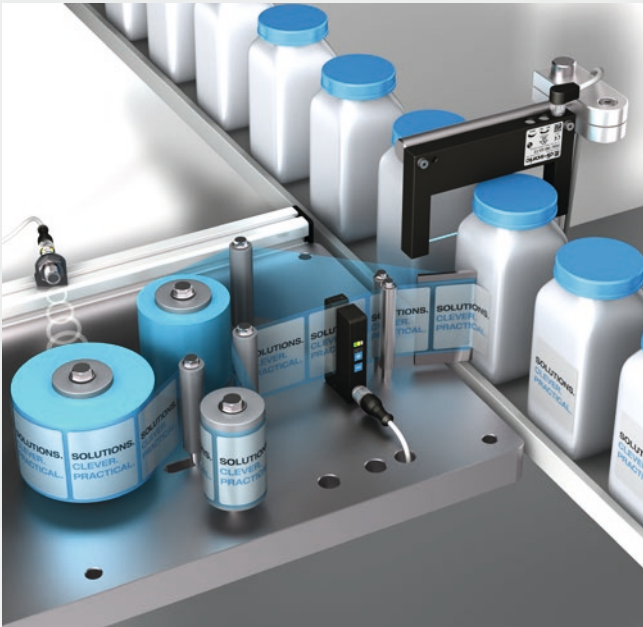

COMPLETE SOLUTIONS USING IO-LINK

IO-Link provides true added value over the entire service life of a system.

The installation and commissioning of highly diverse sensors is simpler and faster whenever the use of plug connectors replaces full wiring.

IO-Link allows flexible, affordable and space-saving systems to be created that are available to the customer faster than ever before.

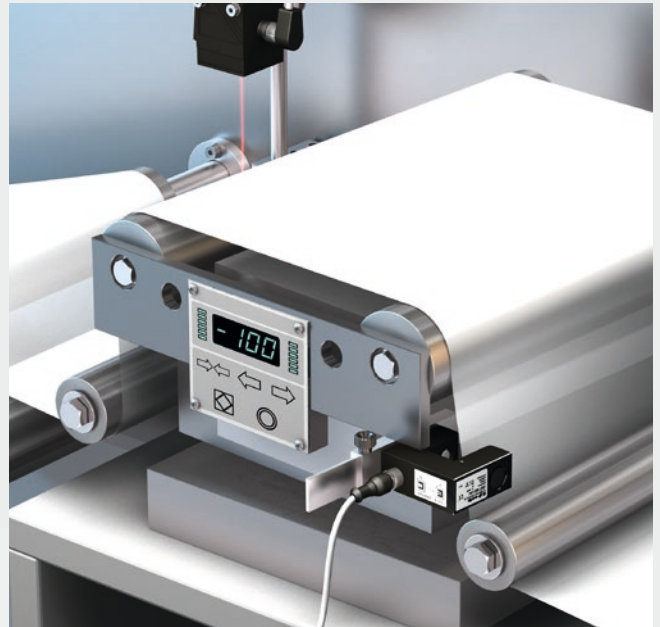

THE MEASURING SENSORS FOR LABELING TECHNOLOGY

Our product portfolio includes measuring sensors, which are required for manufacturing labels.

Whether you want to measure diameters, sag and edge positions or identify labels and their positions—our company provides you with everything from a single source, from start to finish, regardless of what materials you are processing.

YOU ARE OUR PARTNER.

Your success is our success. That's why we are dedicated to fulfilling the requirements and requests of our customers. We accomplish this by providing top-quality products and clever complete solutions in addition to an array of user-oriented services.

TECHNICAL SALES CONSULTANTS

Over 25 expert technical sales consultants are on hand to assist you in product selection and to answer your questions on implementing our devices.

We would be glad to visit you on-site to demonstrate solutions for your applications.

Just set up an appointment.

Contact our in-house staff for information on pricing and availability checks. They'll advise you personally and are happy to send you documents and templates on request.

They process your orders quickly and reliably to ensure that the orders leave our warehouse on time and arrive on your requested delivery date.

CUSTOMER CONSULTATION BY PHONE

Do you have specific technical questions about our products? Our employees in Technical Support offer advice on all issues related to products and applications.

We're happy to provide you with support to ensure your production process runs smoothly, in Europe or even on-site in Asia.

TECHNICAL SUPPORT

Order the product that meets your needs at any time—day or night. A clear layout, intelligent search function and the product finder will help you to select the right product.

DI-SORIC E-SHOP

SOLUTIONS. CLEVER. PRACTICAL.

**di-soric
GmbH & Co. KG**

Steinbeisstrasse 6
73660 Urbach
Germany

Phone: +49 71 81 98 79-0
Fax: +49 71 81 98 79-179

info@di-soric.com
www.di-soric.com

**di-soric Solutions
GmbH & Co. KG**

Steinbeisstrasse 6
73660 Urbach
Germany

Phone: +49 71 81 98 78-0
Fax: +49 71 81 98 78-177

solutions@di-soric.com
www.di-soric-solutions.com

**di-soric
International**

di-soric GmbH & Co. KG | Germany
di-soric Solutions GmbH & Co. KG | Germany
di-soric Austria GmbH & Co. KG | Austria
di-soric SAS | France
di-soric SNT AG | Switzerland
di-soric Pte. Ltd. | Singapore

www.di-soric.com/international